

A classic  
bathware  
collection



**TRADEANANTA INTERNATIONAL LLP**  
Cell : +91 97148 89595 | email : [contact@tradeananta.com](mailto:contact@tradeananta.com)  
[www.tradeananta.com](http://www.tradeananta.com)

\*Disclaimer : The Product images and specs are proprietary property of respective manufacturer.



**TRADEANANTA**  
We Exchange Trust



Artis  
the root  
of life

## PRODUCT CHARACTERISTICS



All seats and covers are subjected to a weight test.



All seats and covers are subjected to an open/close test.



All WC pans are subjected to an odor leakage test.



Saves water with only 1 Ltr. of water consumption.



Soft Close Seats & Covers  
Soft Closing and silent  
Special technology



Requires very little space and provides easy bottom cleaning.



Anti Bacterial Glazed

# TOILETS

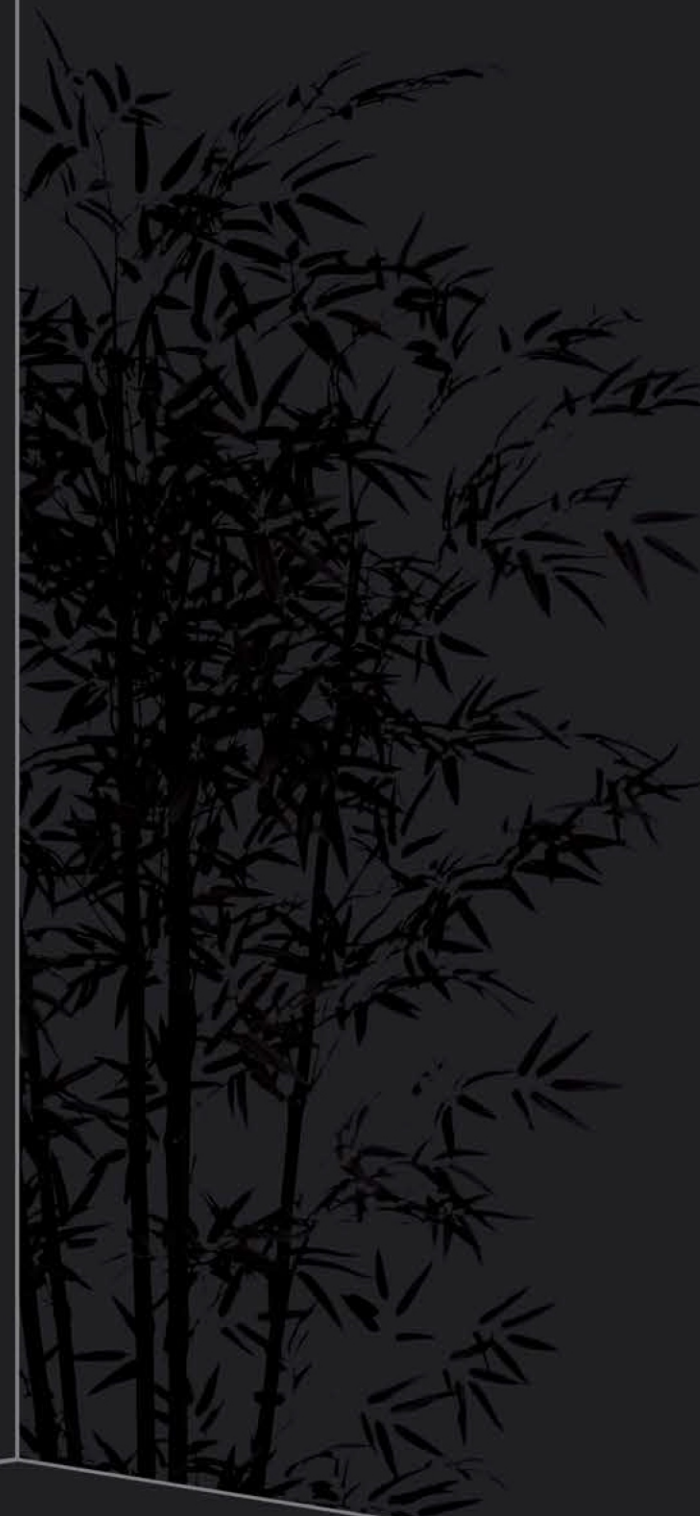

ONE PIECE  
WATER CLOSET  
WALL HUNG

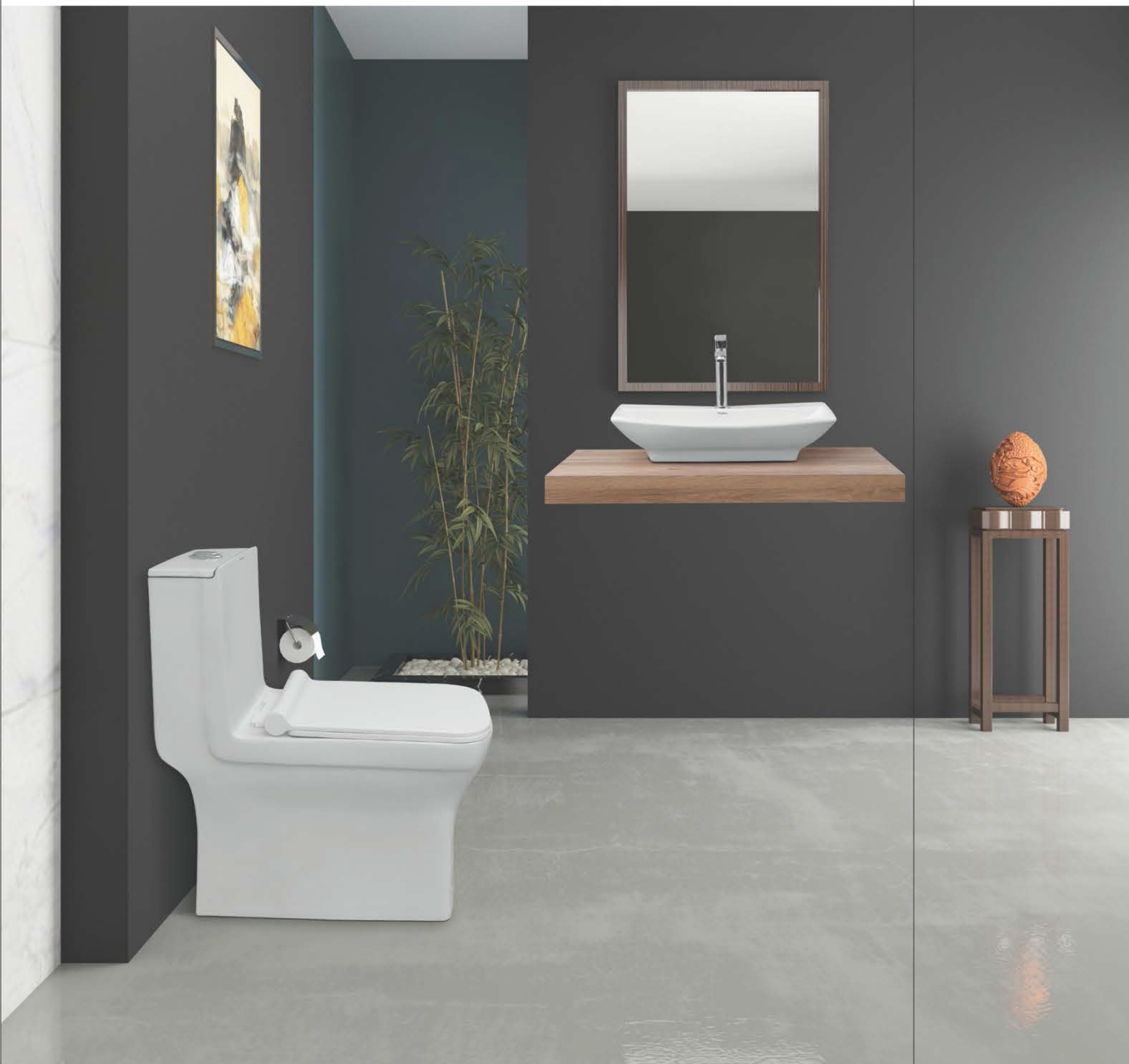

1011 - Civik

L670xW360xH720mm  
S Trap - 225mm(9"),100mm(4")



3302 - Yana

L560xW380xH120mm | 22"X15"

ONE PIECE

1005 - Volvo



RIMLESS | SYPHONIC  
L670xW355xH750mm  
S Trap - 225mm(9"), 300mm(12")

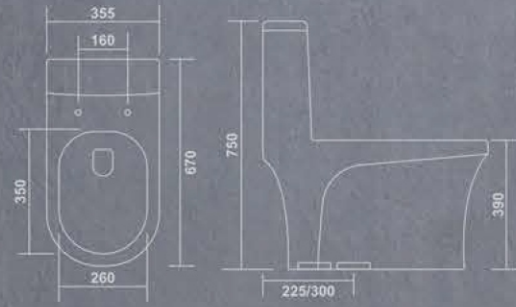

1006 - Duster

L670xW370xH715mm  
S Trap - 225mm(9")

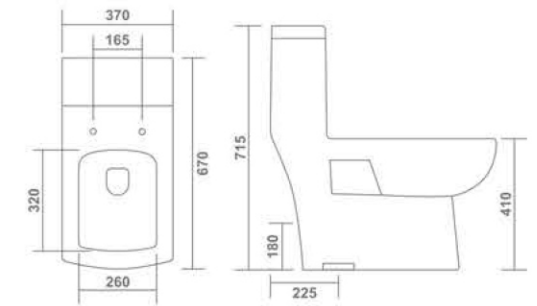

1007 - Brezza

L700xW390xH700mm  
S Trap - 225mm(9")

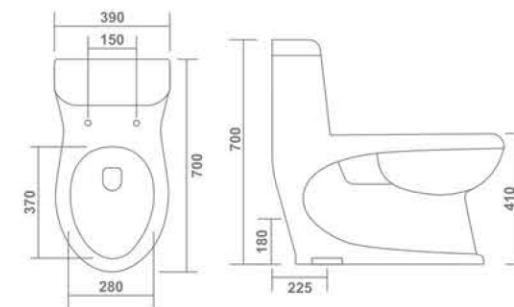

ONE PIECE

1009 - Verna

L650xW350xH720mm  
S Trap - 225mm(9")

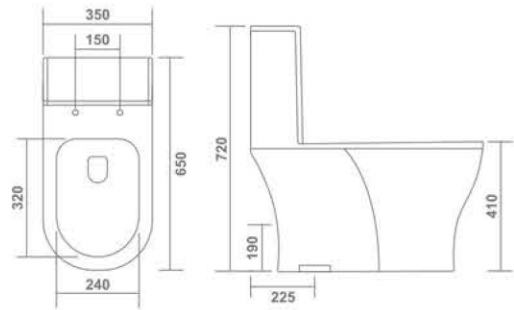

1008 - Creta

L700xW390xH680mm  
S Trap - 225mm(9")

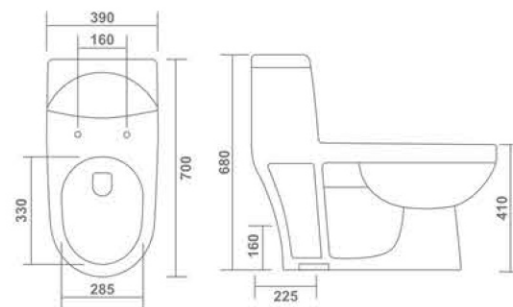

ONE PIECE



1010 - Rapid

L670xW380xH730mm  
S Trap - 225mm(9")

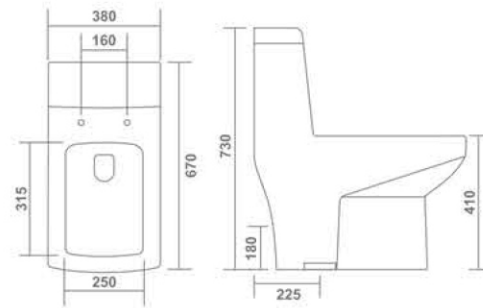

1012 - Vento

RIMLESS | SYPHONIC  
L670xW370xH750mm  
S Trap - 225mm(9"), 300mm(12")

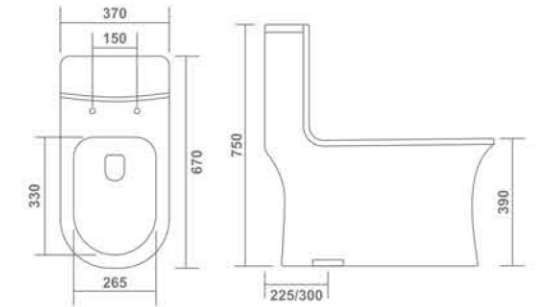

1011 - Civik

L670xW360xH720mm  
S Trap - 225mm(9"), 100mm(4")

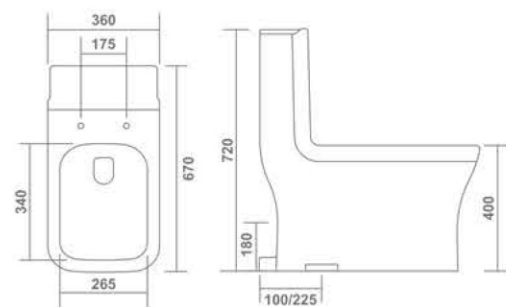

COUPLE SUITE



1014 - Venus

4D-RIMLESS | SYPHONIC  
L660xW360xH730mm  
S Trap - 225mm(9"), 300mm(12")



3323 - Lino

L600xW380xH110mm | 24"X15"



6201 - Euro Set

(PED-201)  
L570xW430xH850mm | 22"X17"



2008 - Spyker

L490xW350xH340mm





ONE PIECE



### 1014 - Venus

4D-RIMLESS | SYPHONIC  
L660xW360xH730mm  
S Trap - 225mm(9"), 300mm(12")

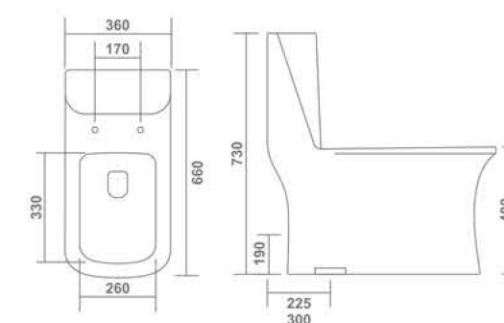

### 1013 - Ripon

L660xW350xH745mm  
S Trap - 225mm(9")

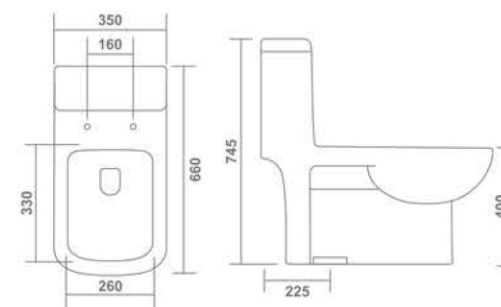

ONE PIECE

FAST WASH  
AESTHETIC  
& HYGIENE

**4D** TECHNOLOGY

*BEGINNING OF A NEW ERA  
OF 4D TECHNOLOGY*



WATER CLOSET

Square Concealed

L505xW340xH400mm



WATER CLOSET



Cello - EWC-S

L510xW365xH410mm

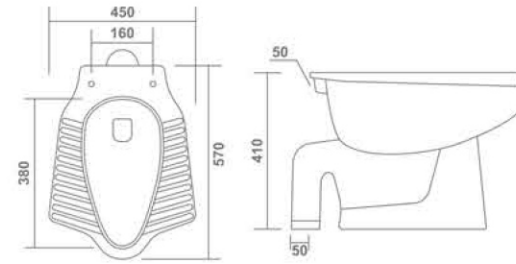
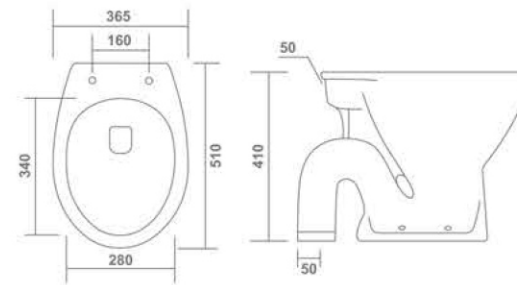

Anglo-S

L570xW450xH410mm



Anglo-P

L520xW450xH410mm

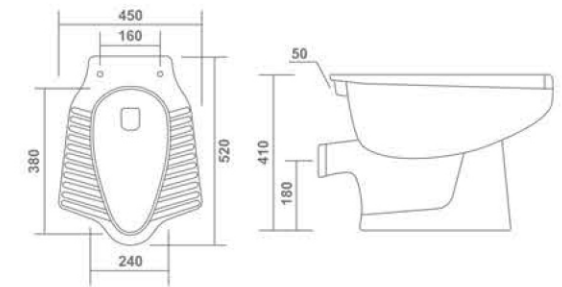

Cello - EWC-P

L510xW365xH410mm

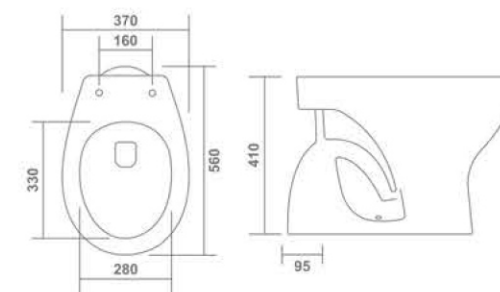
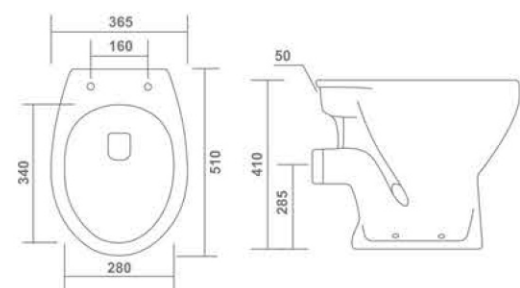

EWC - Concealed

L560xW370xH410mm

WATER CLOSET



Cello - EWC-S

L510xW365xH410mm

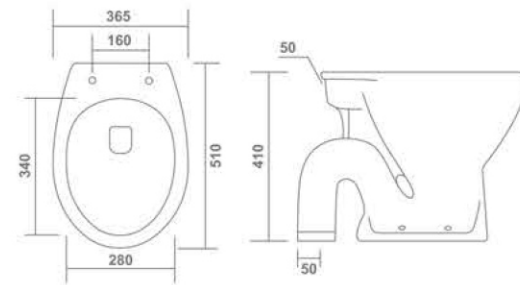

EWC-Concealed

L560xW370xH410mm

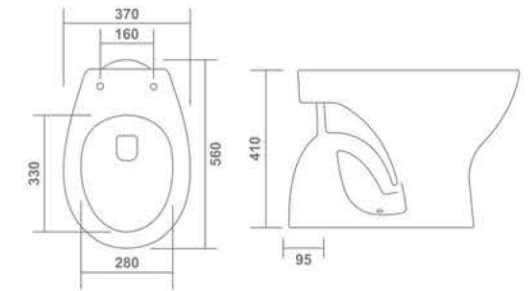

Anglo-S

L570xW450xH410mm



Square Concealed

L505xW340xH400mm

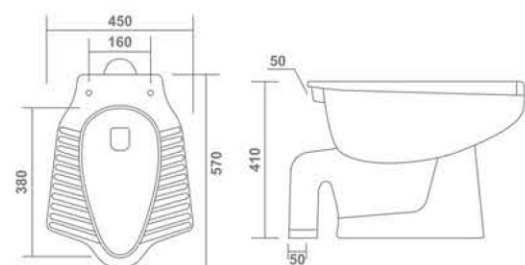

COUPLE SUITE



2005 - Classy

RIMLESS  
L510xW360xH350mm



3310 - Toyo

L430xW430xH130mm | 17"X17"





2004 - Morden

RIMLESS  
L510xW365xH350mm

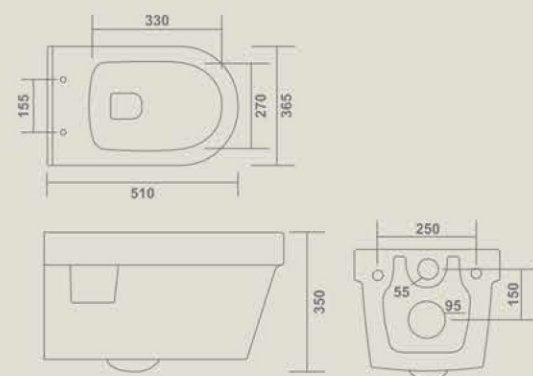

**RIMLESS  
DESIGN**

Toilet bowl without an edge



2005 - Classy

RIMLESS L510xW360xH350mm

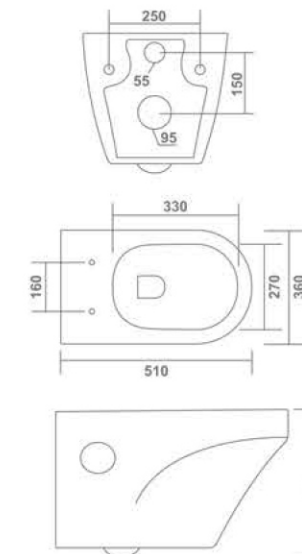

2003 - Croma

L450xW360xH360mm

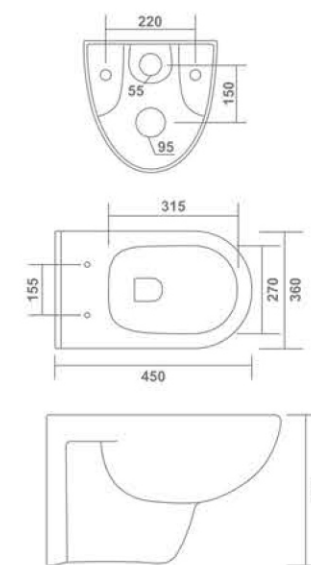

WALL HUNG



2006 - Cosmo

L520xW350xH360mm

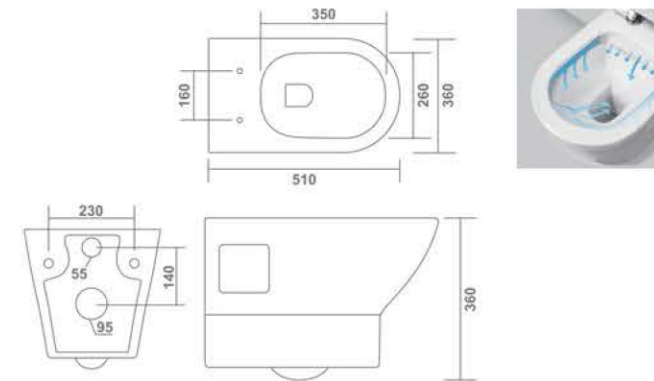
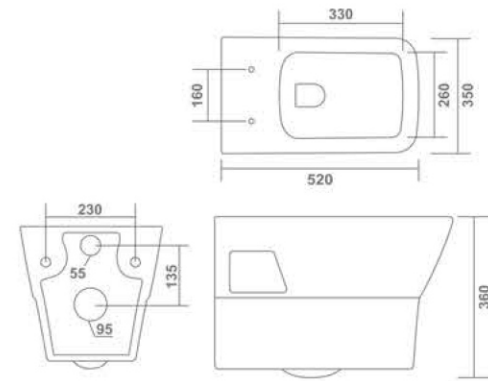

2009 - Coco

RIMLESS L510xW360xH360mm

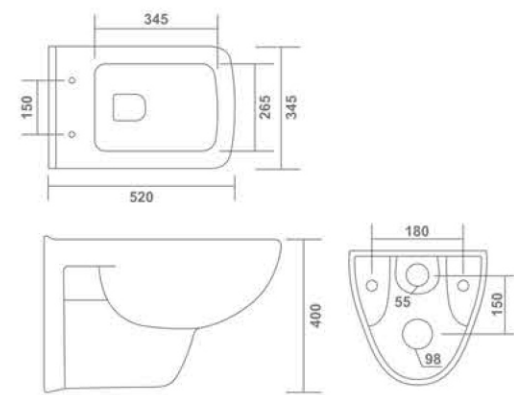

2007 - Crenza

L520xW345xH400mm



2011 - Iris

L510xW350xH350mm

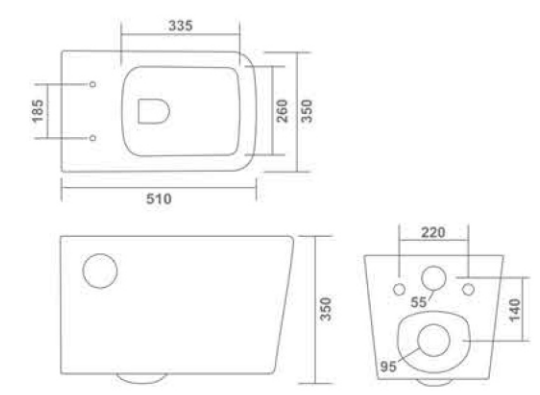

2008 - Spyker

L490xW350xH340mm

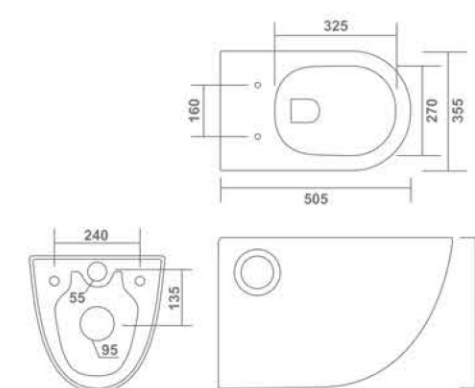
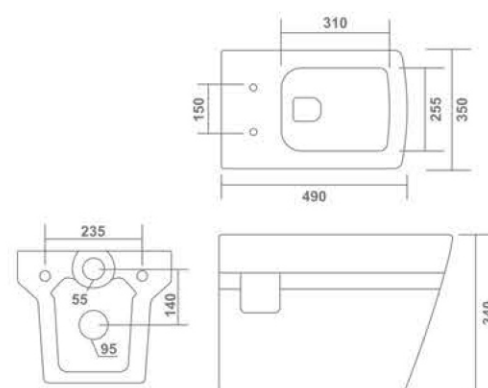

2012 - Rio

L505xW355xH360mm

COUPLE SUITE



3319 - Smart

L500xW380xH130mm | 20"X15"



2011 - Iris

L510xW350xH350mm





# BASINS



TABLE TOP

WASH BASIN PEDESTAL

WASH BASIN HALF PEDESTAL

COUNTER BASIN

ONE PIECE BASIN

WASH BASIN



3307 - Viva

L480xW365xH130mm | 19"X14"



2006 - Cosmo

L520xW350xH360mm

TABLE TOP

3302 - Yana

L560xW380xH120mm | 22"x15"

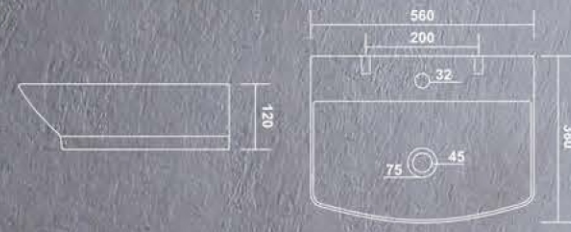

3307 - Viva

L480xW365xH130mm | 19"x14"

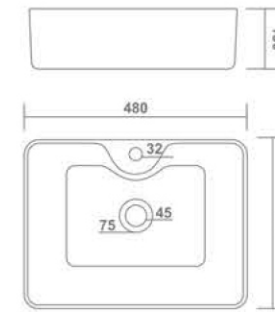

3304 - Vista

L610xW470xH140mm | 24"x19"

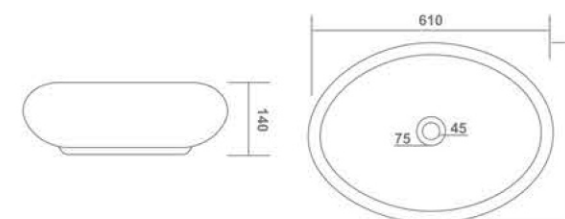

3303 - Apple

L420xW350xH170mm | 16"x14"

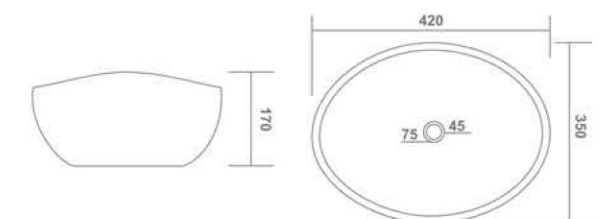

TABLE TOP

5mm Thickness  
**Thin Rim**

Elegant THIN EDGE basin with fine edges that is only 5 mm in thickness. The Attractive clay art is made by the innovative material used by us.



Extremely Light Weight



Perfectly Glazed



3308 - Lia | L410xW410xH160mm | 16"X16"

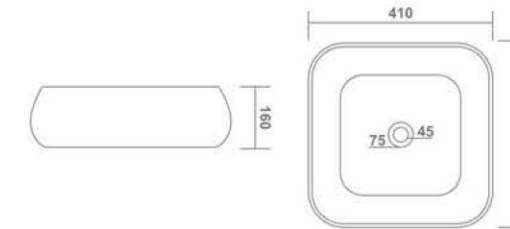

3309 - Alfa | L600xW410xH110mm | 24"X16"

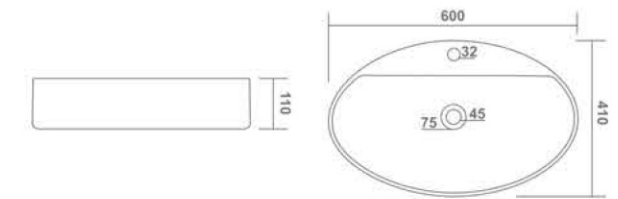

3310 - Toyo | L430xW430xH130mm | 17"X17"

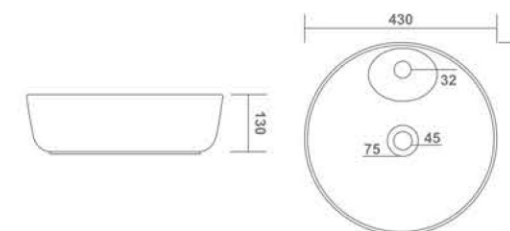

3311 - Rico | L450xW450xH120mm | 18"X18"

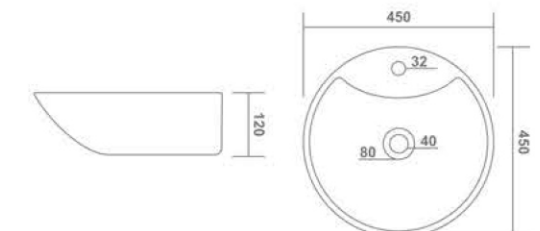
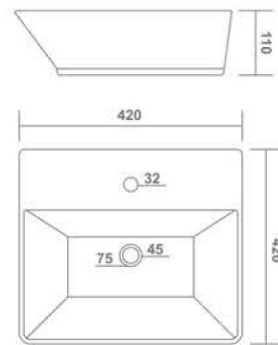

TABLE TOP



3313 - Erica

L420xW420xH110mm | 16"X16"



3315 - Nixon

L460xW340xH130mm | 18"X13"

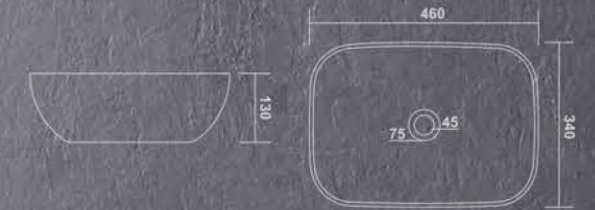

3317 - Selvo

L465xW465xH120mm | 18"X18"

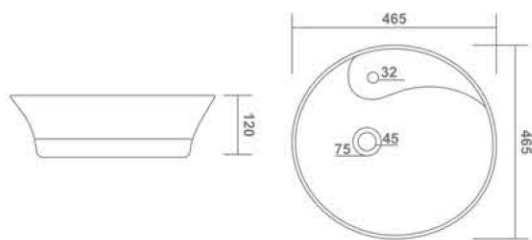
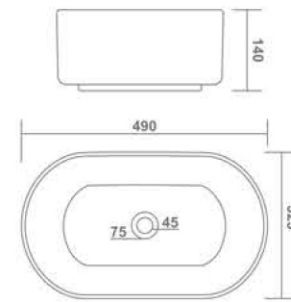
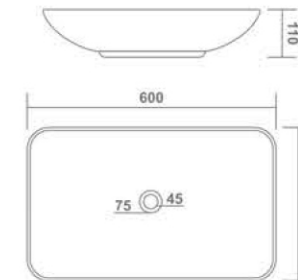

TABLE TOP



3320 - Smile

L490xW325xH140mm | 19"X13"



3323 - Lino

L600xW380xH110mm | 24"X15"



3319 - Smart

L500xW380xH130mm | 20"X15"

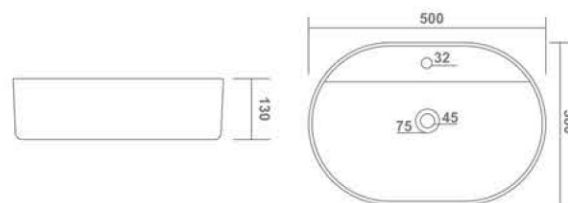

3321 - Pluto

L485xW390xH140mm | 19"X15"

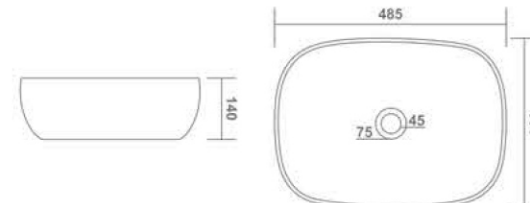

3322 - Spice

L420xW420xH125mm | 16"X16"

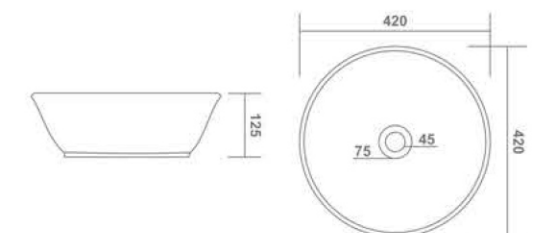
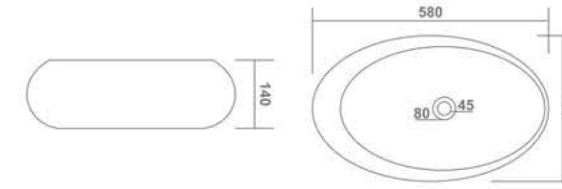
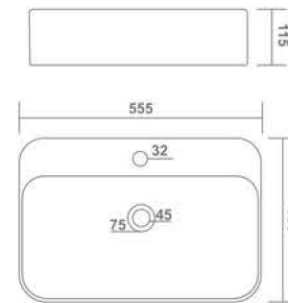

TABLE TOP



3324 - Sheep

L555xW385xH115mm | 22"X15"



3326 - Zucca

L580xW375xH140mm | 23"X15"



3327 - Star

L520xW420xH155mm | 20"X16"

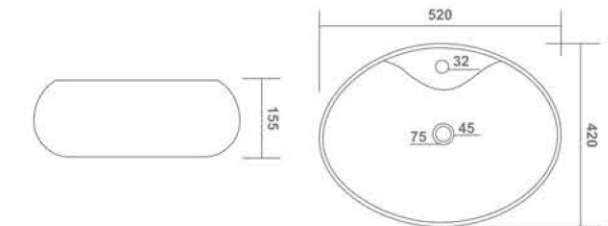

3325 - Cherry

L420xW350xH170mm | 16"X14"

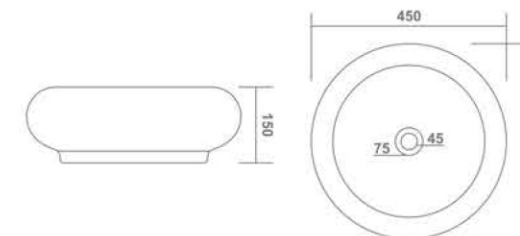
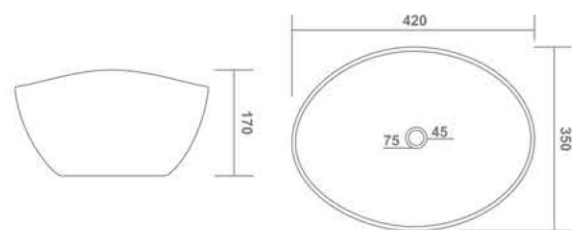

3328 - Avery

L450xW450xH150mm | 18"X18"

TABLE TOP



3329 - Grace | L610xW305xH135mm | 24"x12"

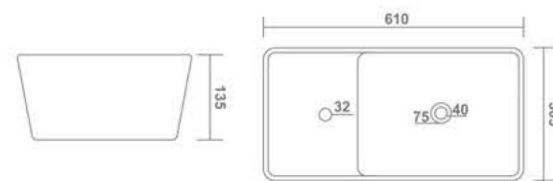

3330 - Orbit | L405xW405xH125mm | 16"x16"

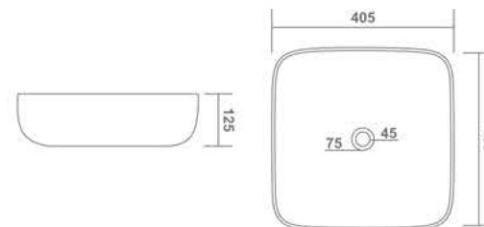

3335 - Latina | L440xW440xH120mm | 17"x17"

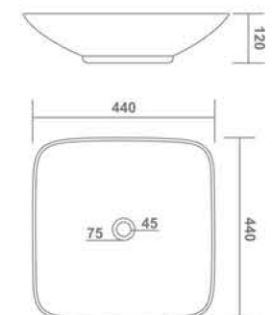

3331 - Specto | L560xW420xH130mm | 22"x16"

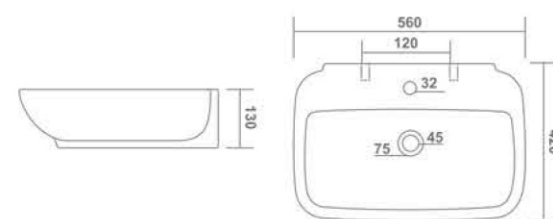

3332 - Plazma | L420xW420xH170mm | 16"x16"

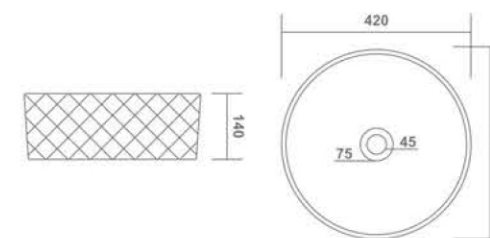
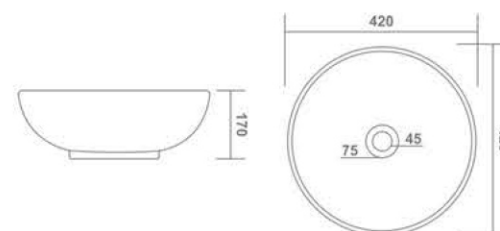

3333 - Aron | L420xW420xH140mm | 16"x16"



COUPLE SUITE



6215 - Ray Set

(PED-215)  
L570xW410xH845mm | 22"X16"



1005 - Volvo

RIMLESS | SYPHONIC  
L670xW355xH750mm  
S Trap - 225mm(9"), 300mm(12")



## WASH BASIN PEDESTAL

### 6201 - Euro Set

(PED-201)  
L570xW430xH850mm | 22"X17"

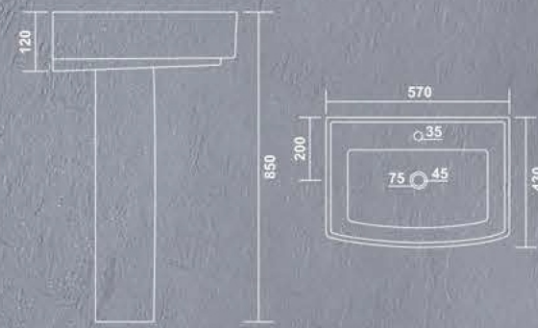

### 6202 - Serena Set

(PED-202)  
L590xW480xH955mm | 23"X18"  
L560xW420xH930mm | 22"X16"

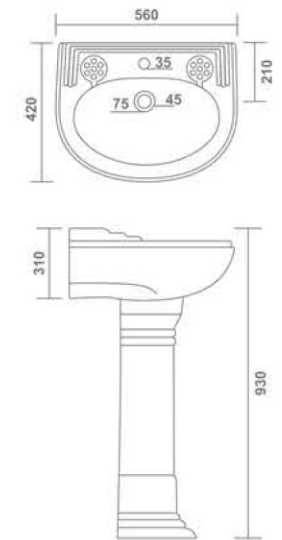

### 6203 - Lexo Set

(PED-203)  
L600xW490xH860mm | 23"X19"

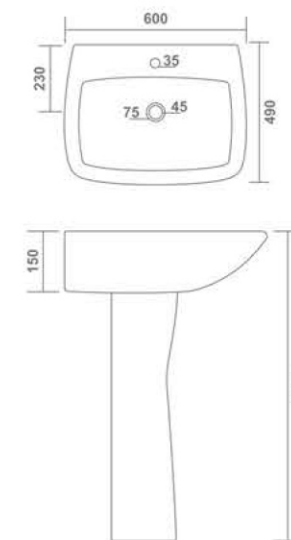

# WASH BASIN PEDESTAL



6205 - Royal Set

(PED-201)  
L580xW420xH870mm | 23"x16"

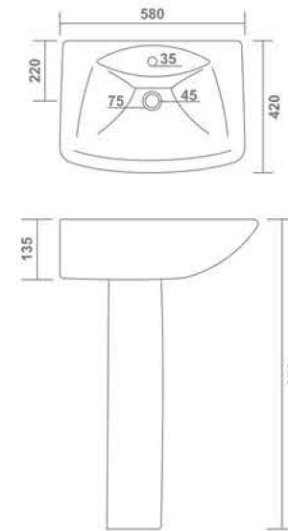

6207 - Deluxe Set

(PED-204)  
L570xW440xH850mm | 22"x17"

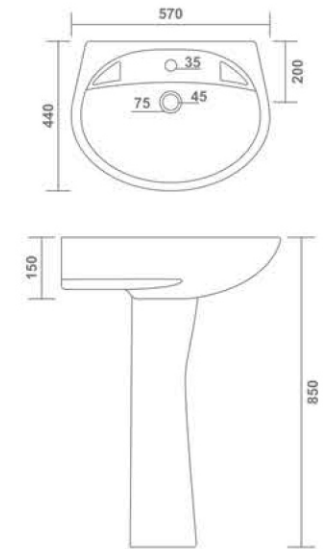

6206 - Sophia Set

(PED-206)  
L580xW440xH860mm | 23"x17"

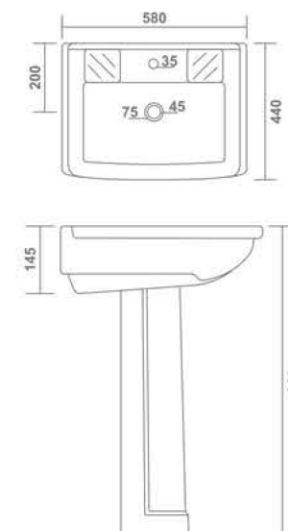

6210 - Yuga Set

(PED-201)  
L570xW445xH875mm | 22"x17"

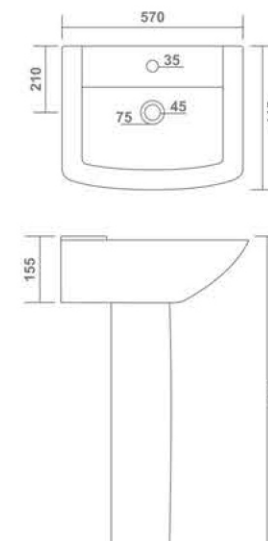

WASH BASIN PEDESTAL

6211 - Glory Set

(PED-211)  
L530xW420xH810mm | 21"X16"

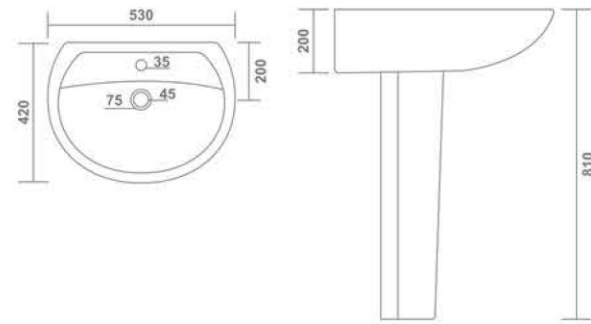

6213 - Dolphin Set

(PED-213)  
L460xW545xH875mm | 18"X21"

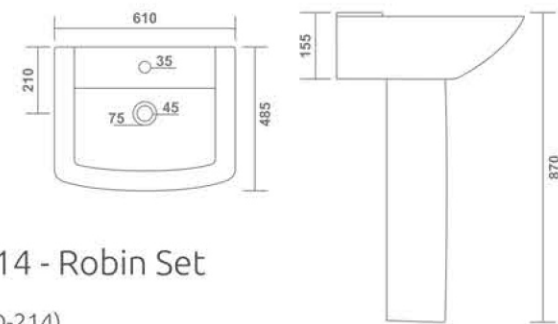
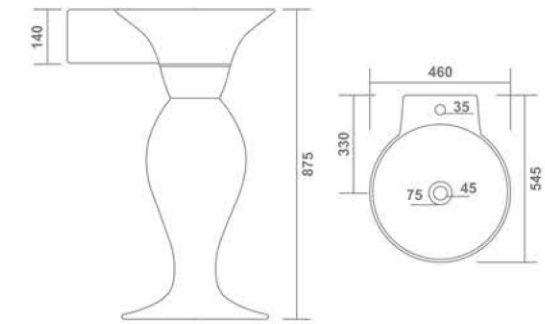

6214 - Robin Set

(PED-214)  
L610xW485xH870mm | 24"X19"

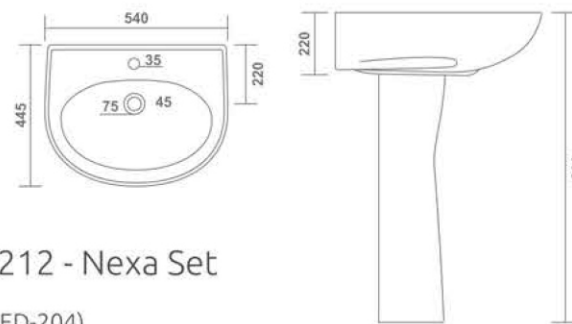

6212 - Nexa Set

(PED-204)  
L540xW445xH830mm | 21"X17"

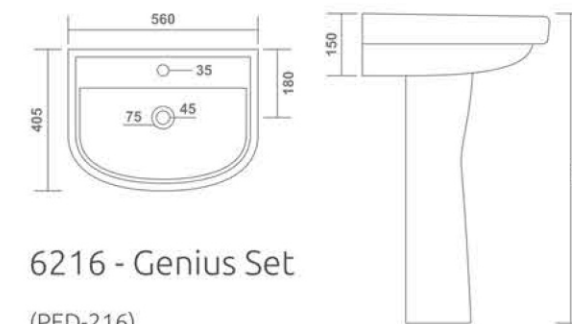

6216 - Genius Set

(PED-216)  
L560xW405xH880mm | 22"X16"

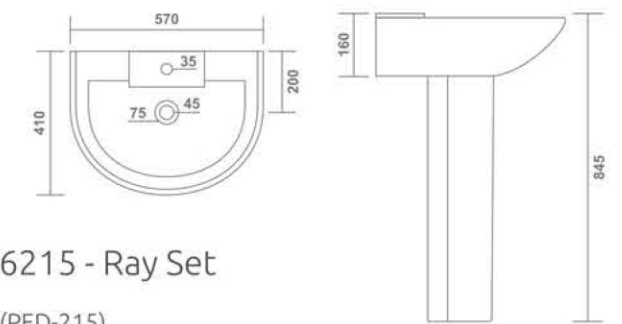

6215 - Ray Set

(PED-215)  
L570xW410xH845mm | 22"X16"



WASH BASIN HALF PEDESTAL

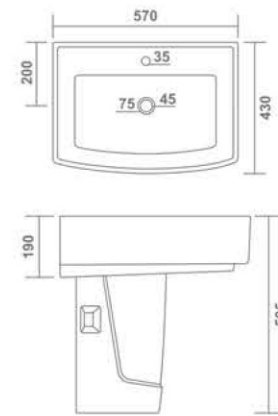

6201 - Euro

(PED-251) L570xW430xH505mm (22"x17")

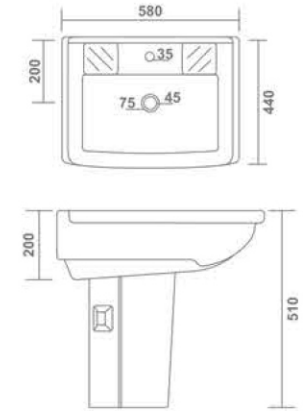

6206 - Sophia

(PED-252) L580xW440xH510mm (23"x17")

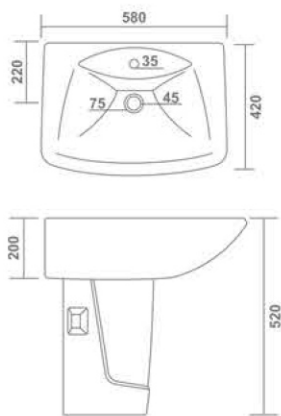

6205 - Royal

(PED-251)  
L580xW420xH520mm (23"x16")

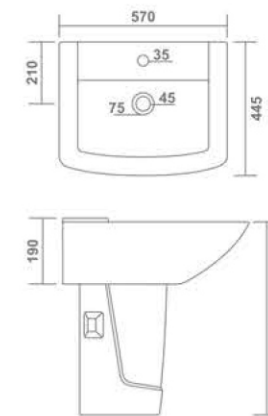

6210 - Yuga

(PED-251) L570xW445xH520mm (22"x17")

COUNTER BASIN



5505 - Omega

L605xW470xH180mm | 24"X19"

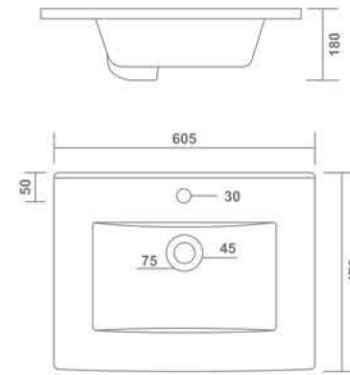

ONE PIECE BASIN

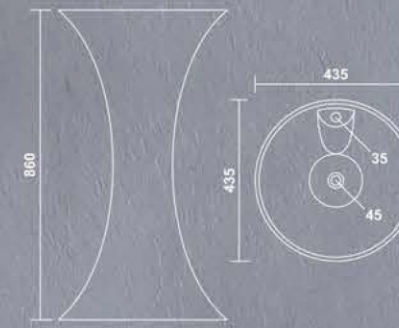

5555 - Atlanta

L435xW435xH860mm | 17"X17"



5504 - Ovel

L570xW420xH200mm | 22"X16"

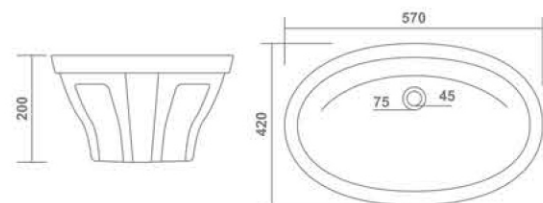

5503 - Fifa

L560xW405xH190mm | 22"X16"

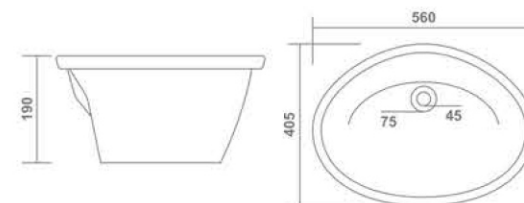



5551 - Compaq

L395xW375xH280mm | 15"X15"



1009 - Verna

L650xW350xH720mm  
S Trap - 225mm(9")

ONE PIECE BASIN

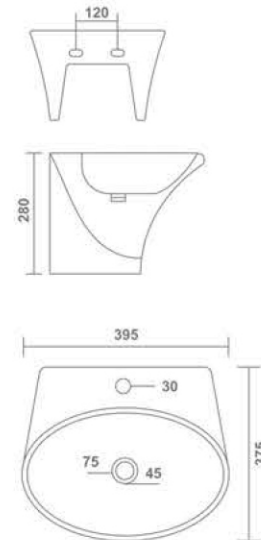

5551 - Compaq

L395xW375xH280mm | 15"X15"

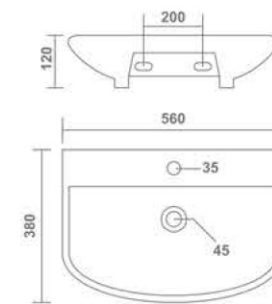

3302 - Yana

L560xW380xH120mm | 22"X15"



3331 - Specto

L560xW420xH130mm | 22"X16"



3313 - Erica

L420xW420xH110mm | 16"X16"

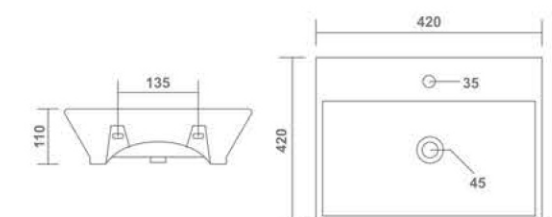
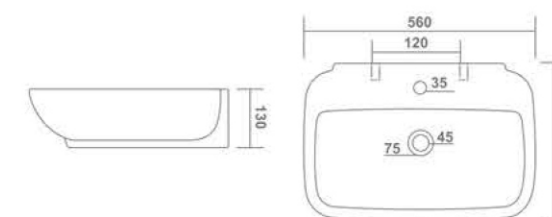

5552 - Sigma

L400xW320xH300mm | 16"X12"

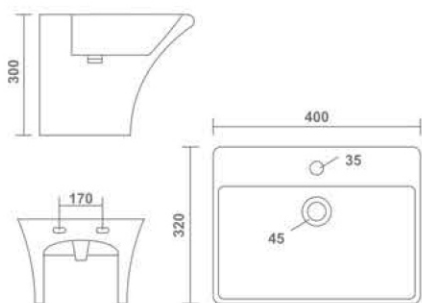



WASH BASIN

4409 - Arya

L460xW335xH135mm | 18"X13"

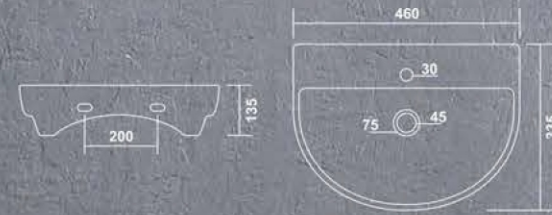

4401 - Niki

L375xW270xH130mm | 15"X11"

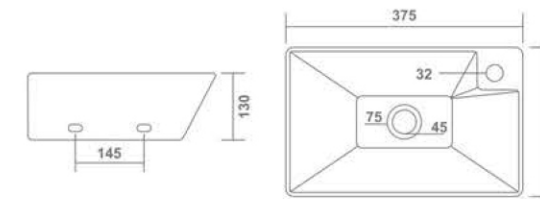

4402 - Doli

L380xW310xH180mm | 14"X11"

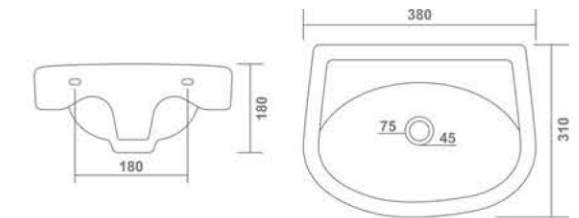

4403 - Lena

L460xW365xH180mm | 18"X14"

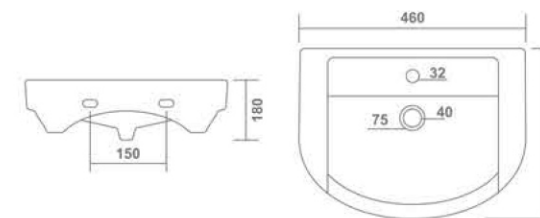

4404 - Ruby

L465xW315xH200mm | 18"X12"

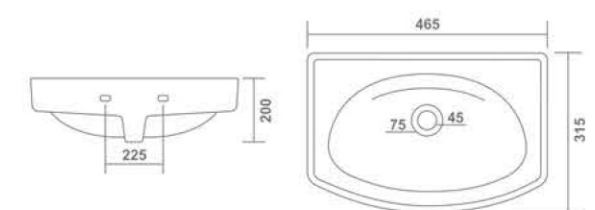

WASH BASIN

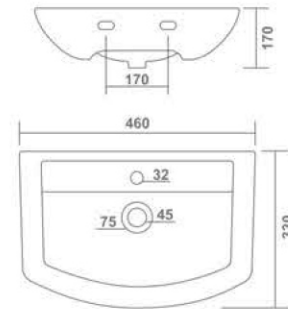

4405 - Mexy

L460xW330xH170mm | 18"X13"

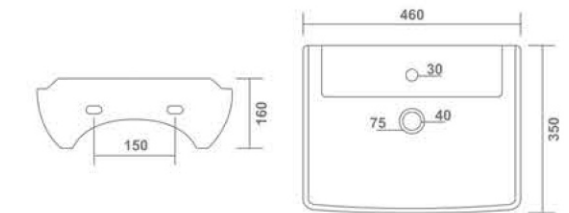

4407 - Archi

L460xW350xH160mm | 18"X14"

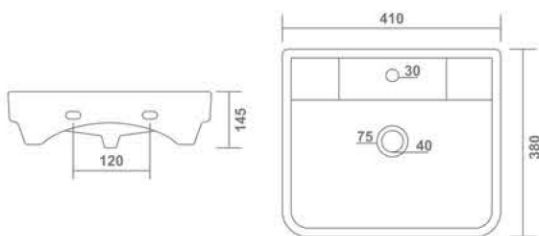

4406 - Bela

L410xW380xH145mm | 16"X15"

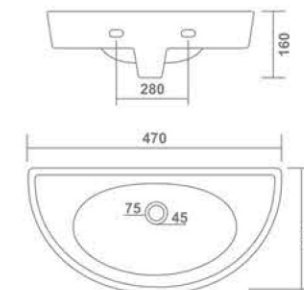

4408 - Krisha

L470xW260xH160mm | 18"X10"

WASH BASIN



4410 - Corner | L520xW430xH140mm | 20"X17"

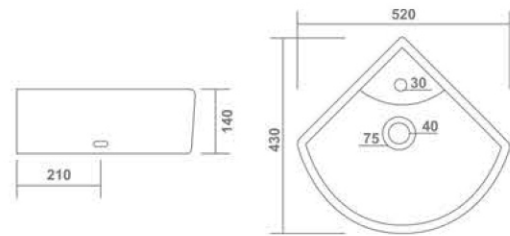

4411 - Corner | L350xW380xH135mm | 14"X15"

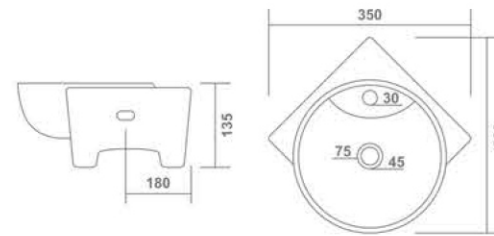

4414 - Alvin | L445xW330xH140mm | 18"X13"

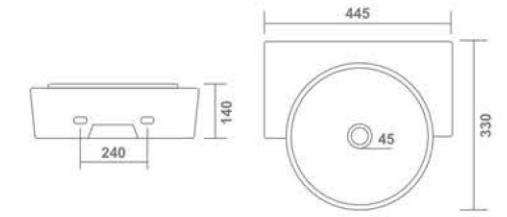

4422 - Corner | L410xW410xH210mm | 16"X16"

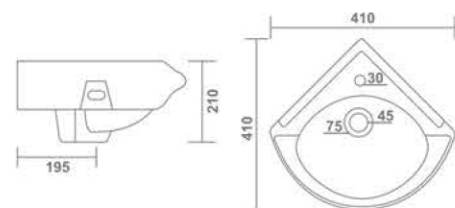

4413 - Eva | L400xW310xH130mm | 16"X12"

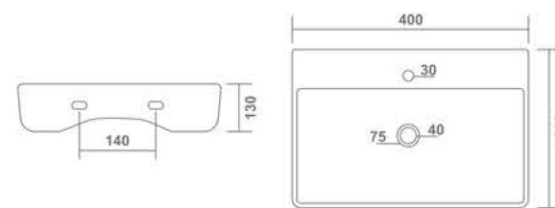

4416 - Decor | L510xW410xH170mm | 20"X16"

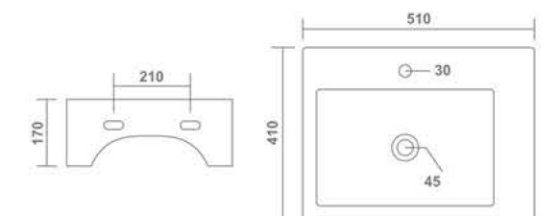

4415 - Pixal | L560xW410xH120mm | 22"X16"

WASH BASIN

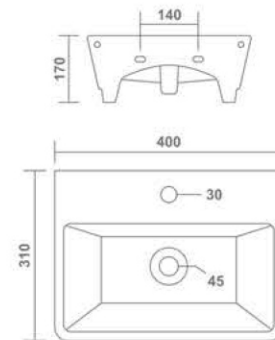

4417 - Cube

L400xW310xH170mm | 16"X12"



4419 - Vipro

L405xW250xH120mm | 16"X10"

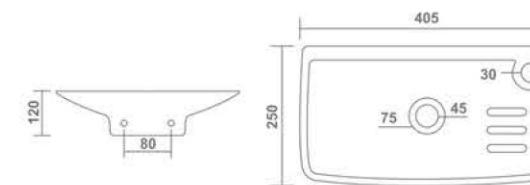

4420 - Navya

L410xW360xH150mm | 16"X14"

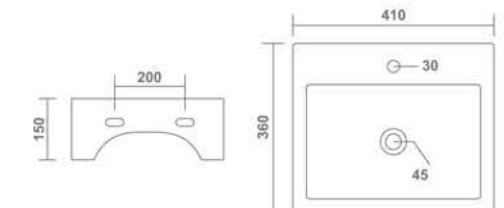

4421 - Sara

L305xW245xH180mm | 12"X9"

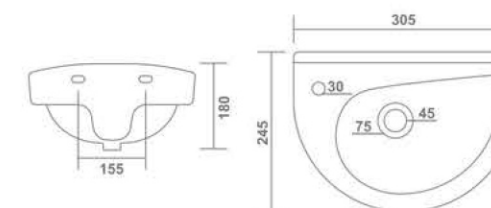

4412 - Leo

L420xW270xH160mm | 16"X10"

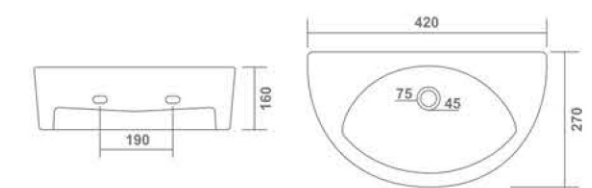

4418 - Opel

L460xW230xH155mm | 18"X9"

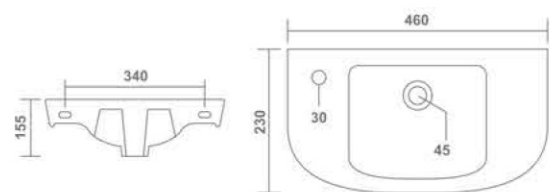

URINAL



701 - Large Urinal L390xW380xH610mm

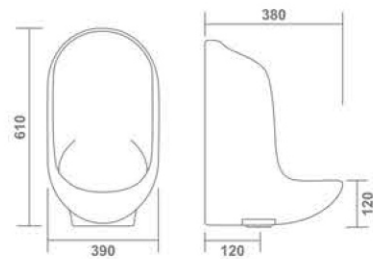

702 - Accord Urinal L380xW370xH690mm

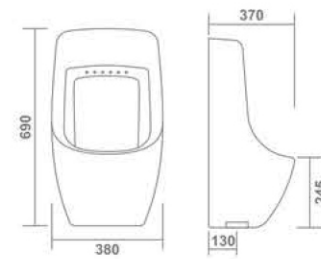

704 - Flatback Urinal L350xW275xH460mm

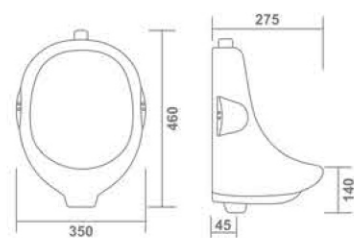

703 - Squatting Urinal L440xW360xH100mm

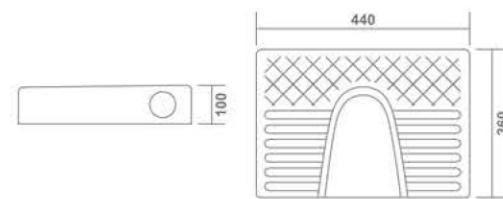

PAN



Aqua Pan (21'') L530xW420xH265mm

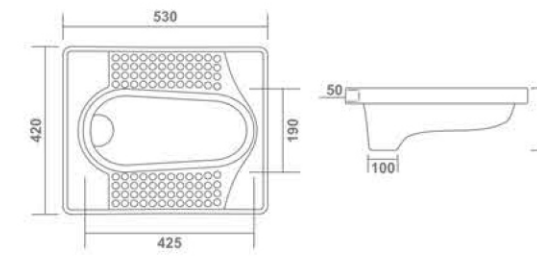

Orissa Pan (20'') L510xW410xH260mm

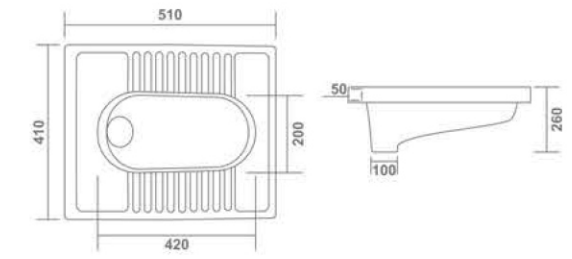

CT Pan (20'') L525xW420xH180mm

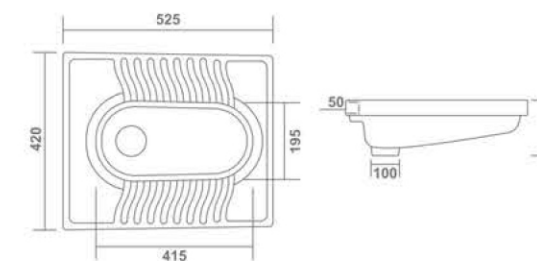

Orissa Pan (23'') L590xW445xH310mm

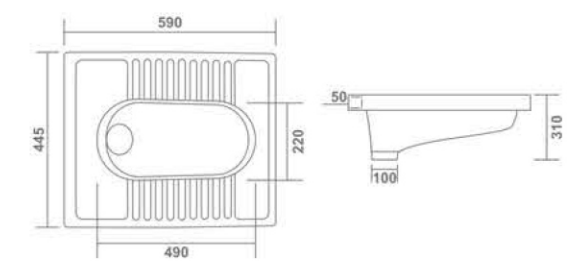



# DESIGNER SERIES

WASH BASIN PEDESTAL  
WALL HUNG  
ONE PIECE  
TABLE TOP

WASH BASIN PEDESTAL



Serena-501

L560xW420xH930mm | 22"X16"



Serena-504

L560xW420xH930mm | 22"X16"

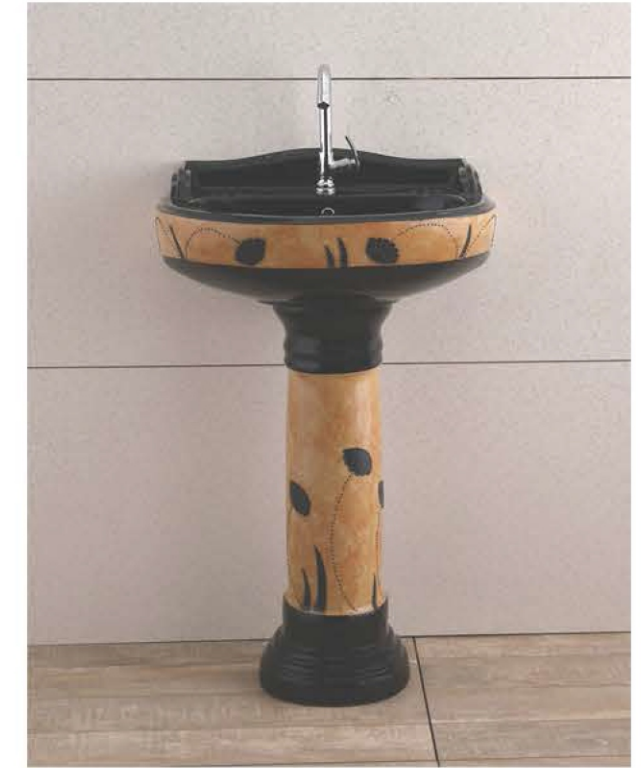

Serena-505

L560xW420xH930mm | 22"X16"



Serena-502

L560xW420xH930mm | 22"X16"



Serena-503

L560xW420xH930mm | 22"X16"



Serena-506

L560xW420xH930mm | 22"X16"

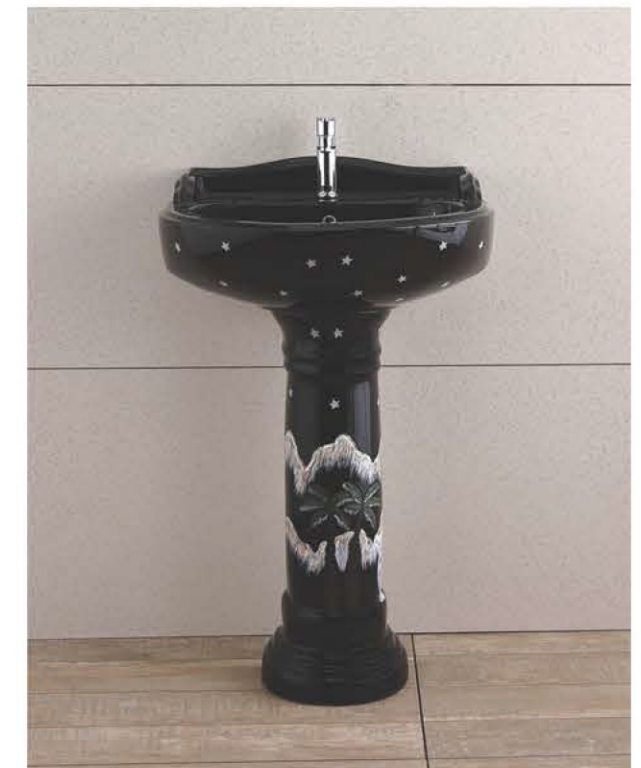

Serena-507

L560xW420xH930mm | 22"X16"

WASH BASIN PEDESTAL



Serena-508 | L560xW420xH930mm | 22"x16"



Serena-509 | L560xW420xH930mm | 22"x16"



Euro-533 | L570xW430xH850mm | 22"x17"



Euro-531 | L570xW430xH850mm | 22"x17"



Euro-532 | L570xW430xH850mm | 22"x17"



Euro-534 | L570xW430xH850mm | 22"x17"



Euro-535 | L570xW430xH850mm | 22"x17"



WASH BASIN PEDESTAL



Deluxe-591 | L570xW440xH850mm | 22"x17"



Deluxe-592 | L570xW440xH850mm | 22"x17"



Dolphin-563 | L460xW545xH875mm | 18"x21"



Dolphin-561 | L460xW545xH875mm | 18"x21"



Dolphin-562 | L460xW545xH875mm | 18"x21"



Dolphin-564 | L460xW545xH875mm | 18"x21"



Dolphin-565 | L460xW545xH875mm | 18"x21"

WASH BASIN PEDESTAL



Dolphin-566 | L460xW545xH875mm | 18"X21"



Dolphin-567 | L460xW545xH875mm | 18"X21"

WALL HUNG



601 - Morden | L510xW365xH350mm

ONE PIECE

611 - Rapid

L670xW380xH730mm



TABLE TOP



Alfa - 301 | L600xW410xH110mm | 24"x16"



Alfa - 302 | L600xW410xH110mm | 24"x16"



Apple - 308 | L420xW350xH170mm | 16"x14"



Apple - 309 | L420xW350xH170mm | 16"x14"



Alfa - 303 | L600xW410xH110mm | 24"x16"



Alfa - 304 | L600xW410xH110mm | 24"x16"



Apple - 310 | L420xW350xH170mm | 16"x14"



Apple - 311 | L420xW350xH170mm | 16"x14"



Alfa - 305 | L600xW410xH110mm | 24"x16"



Alfa - 306 | L600xW410xH110mm | 24"x16"



Apple - 312 | L420xW350xH170mm | 16"x14"



Apple - 338 | L420xW350xH170mm | 16"x14"

TABLE TOP



Apple - 339

L420xW350xH170mm | 16"X14"



Apple - 356

L420xW350xH170mm | 16"X14"



Cherry - 363

L420xW350xH170mm | 16"X14"



Apple - 340

L420xW350xH170mm | 16"X14"



Apple - 341

L420xW350xH170mm | 16"X14"



Lia - 313

L410xW410xH160mm | 16"X16"



Lia - 314

L410xW410xH160mm | 16"X16"



Apple - 342

L420xW350xH170mm | 16"X14"



Apple - 343

L420xW350xH170mm | 16"X14"



Lia - 315

L410xW410xH160mm | 16"X16"



Lia - 391

L410xW410xH160mm | 16"X16"

TABLE TOP



Toyo - 316

L430xW430xH130mm | 17"X17"



Toyo - 321

L430xW430xH130mm | 17"X17"



Toyo - 322

L430xW430xH130mm | 17"X17"



Toyo - 317

L430xW430xH130mm | 17"X17"



Toyo - 318

L430xW430xH130mm | 17"X17"



Toyo - 323

L430xW430xH130mm | 17"X17"



Toyo - 324

L430xW430xH130mm | 17"X17"



Toyo - 319

L430xW430xH130mm | 17"X17"



Toyo - 320

L430xW430xH130mm | 17"X17"



Toyo - 325

L430xW430xH130mm | 17"X17"



Toyo - 326

L430xW430xH130mm | 17"X17"

TABLE TOP



Toyo - 327 | L430xW430xH130mm | 17"x17"



Toyo - 328 | L430xW430xH130mm | 17"x17"



Smile - 365 | L490xW325xH140mm | 19"x13"



Toyo - 330 | L430xW430xH130mm | 17"x17"



Toyo - 390 | L430xW430xH130mm | 17"x17"



Smile - 366 | L490xW325xH140mm | 19"x13"



Smile - 367 | L490xW325xH140mm | 19"x13"



Smile - 348 | L490xW325xH140mm | 19"x13"



Smile - 360 | L490xW325xH140mm | 19"x13"



Smile - 395 | L490xW325xH140mm | 19"x13"



Smile - 396 | L490xW325xH140mm | 19"x13"

TABLE TOP



Pluto - 354

L485xW390xH140mm | 19"X15"



Vista - 333

L610xW470xH140mm | 24"X19"



Vista - 334

L610xW470xH140mm | 24"X19"



Pluto - 361

L485xW390xH140mm | 19"X15"



Pluto - 393

L485xW390xH140mm | 19"X15"



Vista - 359

L610xW470xH140mm | 24"X19"



Vista - 368

L610xW470xH140mm | 24"X19"



Vista - 331

L610xW470xH140mm | 24"X19"



Vista - 332

L610xW470xH140mm | 24"X19"



Vista - 369

L610xW470xH140mm | 24"X19"



Vista - 394

L610xW470xH140mm | 24"X19"

TABLE TOP



Viva - 337 | L480xW365xH130mm | 19"x14"



Viva - 371 | L480xW365xH130mm | 19"x14"



Nixon - 350 | L460xW340xH130mm | 18"x13"



Nixon - 351 | L460xW340xH130mm | 18"x13"



Viva - 372 | L480xW365xH130mm | 19"x14"



Viva - 373 | L480xW365xH130mm | 19"x14"



Nixon - 352 | L460xW340xH130mm | 18"x13"



Nixon - 353 | L460xW340xH130mm | 18"x13"



Viva - 374 | L480xW365xH130mm | 19"x14"



Nixon - 349 | L460xW340xH130mm | 18"x13"



Nixon - 392 | L460xW340xH130mm | 18"x13"



Tora - 370 | L460xW340xH130mm | 18"x13"



TABLE TOP



Smart - 362

L500xW380xH130mm | 20"X15"



Lotus - 344

L450xW450xH140mm | 18"X18"



Lotus - 345

L450xW450xH140mm | 18"X18"



Smart - 355

L500xW380xH130mm | 20"X15"



Smart - 397

L500xW380xH130mm | 20"X15"



Lotus - 346

L450xW450xH140mm | 18"X18"



Lotus - 389

L450xW450xH140mm | 18"X18"



Smart - 398

L500xW380xH130mm | 20"X15"



Smart - 399

L500xW380xH130mm | 20"X15"



Star - 347

L520xW420xH155mm | 20"X16"



Star - 380

L520xW420xH155mm | 20"X16"

TABLE TOP



Zucca - 364

L580xW375xH140mm | 23"X15"



Selvo - 384

L465xW465xH120mm | 18"X18"



Selvo - 385

L465xW465xH120mm | 18"X18"



Aron - 381

L420xW420xH140mm | 16"X16"



Aron - 400

L420xW420xH140mm | 16"X16"



Selvo - 386

L465xW465xH120mm | 18"X18"



Selvo - 387

L465xW465xH120mm | 18"X18"



Plazma - 382

L420xW420xH170mm | 16"X16"



Plazma - 383

L420xW420xH170mm | 16"X16"



Spice - 375

L420xW420xH125mm | 16"X16"



Spice - 376

L420xW420xH125mm | 16"X16"

TABLE TOP



Spice - 377 | L420xW420xH125mm | 16"X16"



Spice - 378 | L420xW420xH125mm | 16"X16"



Spice - 379 | L420xW420xH125mm | 16"X16"



Sheep - 401 | L555xW385xH115mm | 22"X15"



Zucca - 402 | L580xW375xH140mm | 23"X15"



Orbit - 403 | L405xW405xH125mm | 16"X16"

ACCESSORIES



Anglo S/P



E.W.C. S/P, Concealed



1006, 1010, 2008



1013



1008, 1009, 1012, 2004,  
2005, 2009, 2012



1011, 2006, 2007,  
2010, 2011



P-trap



Flush Kit



Rag Bolt



Gasket



Urinal Clamps  
701, 702



Top Fixing Bolt

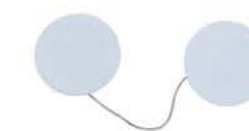

Side Cap



Washer

TROUBLESHOOTING GUIDE

ITEM	PROBLEM	PROBABLE REASONS	CORRECTIVE ACTIONS
Wash Basins / Table Top	1. Overflow Chocked And Foul Bed Odor	Waste Coupling Used May Be Full Threaded	Waste Coupling Should Be Changed To Slot Cut Coupling
	2. Water Deposit On Tap Platform Area And Inside Bowl Area	Basin Is Not Fixed In Level Or Bracket Is Not In Level	Should Be Done By Proper Leveling
	3. There Is No Tap Hole In Basin	Tap Hole Could Be Semi Punched From Back Side	Tap Hole Should Be Created By Plumber From Semipunched Area
Ewc / Pan / Anglo Indian	1. Water Not Coming In Bowl Area While Flushing	Flush Bend Is Not Inserted Up To The End Of Inlet Hole	Insert The Flush Pipe Up To The End Of Inlet ( For Pan Closet: Check Whether Flush Pipe Is Not Covering Flush Hole Which Is In Both Side Of Inlet Wall
		Closet / Pan May Be Not Leveled	Should Be Done By Proper Leveling
One Piece Closet	1. Water Not Coming In Bowl Area While Flushing	Mechanism Inside Tank Could Not Working Properly	Change The Centre Pump Of Mechanism
		There Is No Water In Flush Tank	Increase The Ball Cock Height To The Max Level
	2. Water Is Continuously Leaking Inside The Bowl	Mechanism Inside Tank Could Not Working Properly	Change The Centre Pump Of Mechanism
	3. Water Quantity Insufficient For Effective Flushing	Ball Cock Height Adjusted At Lower Level	Increase The Ball Cock Height To The Max Level
Wallhung Water Closet	1. Water Not Coming In Bowl Area While Flushing	Flush Valve May Not Working Properly / Concealed Cistern Is Not Working Properly	Should Change Flush Valve / Concealed Cistern
		Flush Pipe Is Not Inserted Up To The End Of Inlet Hole	Insert The Flush Pipe Up To The End Of Inlet
	2. Water Is Continuously Leaking Inside The Bowl	Closet Is Not Leveled Properly	Closet Should Be In Proper Level
Couple Closet (2 Pcs Closet)	1. Uneven Flow Of Water From Both Side Of Closet Bowl	Both Arm Of Diverter Pipe Not Inserted Equally In Both Side Of The Closet	Both Arm Of Diverter Pipe Should Be Inserted Equally In Both Side Of The Closet
		Diverter Pipe Not Fixed Properly In The Outlet Of Cistern	Diverter Pipe Should Be Fixed Properly In The Outlet Of Cistern
Couple Closet (2 Pcs Closet)	2. Water Is Leaking Between The Cistern And Closet	Rubber Ring Containing Bolt Is Not Tightened Properly	Rubber Ring Containing Bolt Should Be Tightened Properly

COLOURS



STAR WHITE



IVORY

NOTE :

- Colours printed above may differ from original colours of ceramics. For actual selection refer samples or shade board.
- Due to continuous upgradations, product specifications may change time to time.

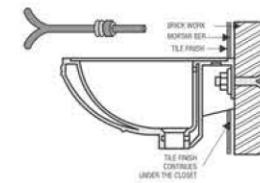

WALL HUNG BASIN

As per shown in the picture, the rag bolt must be grouted into the cement/concrete wall. The bolts must be fixed to the cement/concrete wall. Allow setting & checking than install it using nut and washer.

COUNTER WASHBASIN

At the beginning

1. A skilled or experienced person should install counter lavatories.
2. Avoid using adhesive with this product.
3. Check the waste area and supply tubing if required.
4. Do not open the lavatory from its protective carton until you are ready for installation.
5. Please follow all local building and plumbing codes.

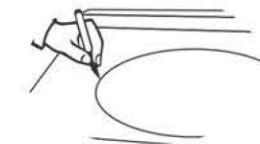

MATERIAL & TOOLS

Measure tape, Keyhole or saber saw, Hammer, Glasses, Rags or Paper toweling, Drill (1/2 dia, drill bit or larger), Pencil, sealant, sharp knife or scissors.

INSTALLATION OF LAVATORY

Please Note : Please install it in a way that future removal from underneath the counter top is possible without damaging the counter top.

1. Please check the desired location for clearance between the back splash, faucet, Fixture and cabinet.
2. Please cut the template.
3. Please carefully trace the template on the counter top directed.
4. Please mark the faucet hole centerline on the counter top.
5. Please drill a 1/2" pilot on the inside of the cut line.

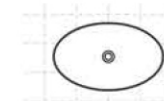

For Wood Counter tops:

1. Mark and per-drill the wood screw holes at the locations shown on the template.
2. Waterproof any exposed areas of wood.

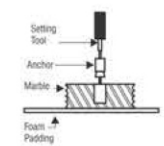

For Marble Counter tops:

1. Position the counter top upside down on foam padding to protect the surface. Mark and drill 3/6" holes 5/8" deep at the locations shown on the template.
2. Use a setting tool and hammer to secure the anchors.



For All Installations:

1. If the counter top has not been installed, install it at this time.
2. Drill the faucet holes according to the faucet installation instructions.
3. Install the faucet to the counter top according to the manufacture's instructions.
4. Install the drain to the lavatory according to the manufacture's instructions.

MAINTENANCE

Like any other part of your house, the bathroom can be made to look great and made to last long if it is taken care of regularly. To make your bathroom beautiful here are some invaluable tips.

Wash Basin :

A mild detergent can be used to wash the basin at least once a day. After washing, the basin should be wiped out clearly to avoid water stains.

Closets :

Cleanser like Harpic can be used to clear the closet with soft plastic brush, at least once a day.

To avoid minute discoloring, after flushing the toilet give it a once over with the soft brush.

Keep the toilet brush handy in a convenient stand nearby.

In case of toilets and basins, if there has been no maintenance since long period of time, water deposits and discoloration can form on the surface of areas that get wet. In such cases, these stains/marks can be removed with the help of a solution of dilute hydrochloric acid.

Clean with a soft cotton cloth and warm water with soap.

Do not use thinner, day cleaning liquids or powder paste. Use a liquid cleaner at least twice a week.

Use brasso or car rubbing compound and then polish with a cloth to remove fine scratches.